

ART. NO.

101082-2

101082-3

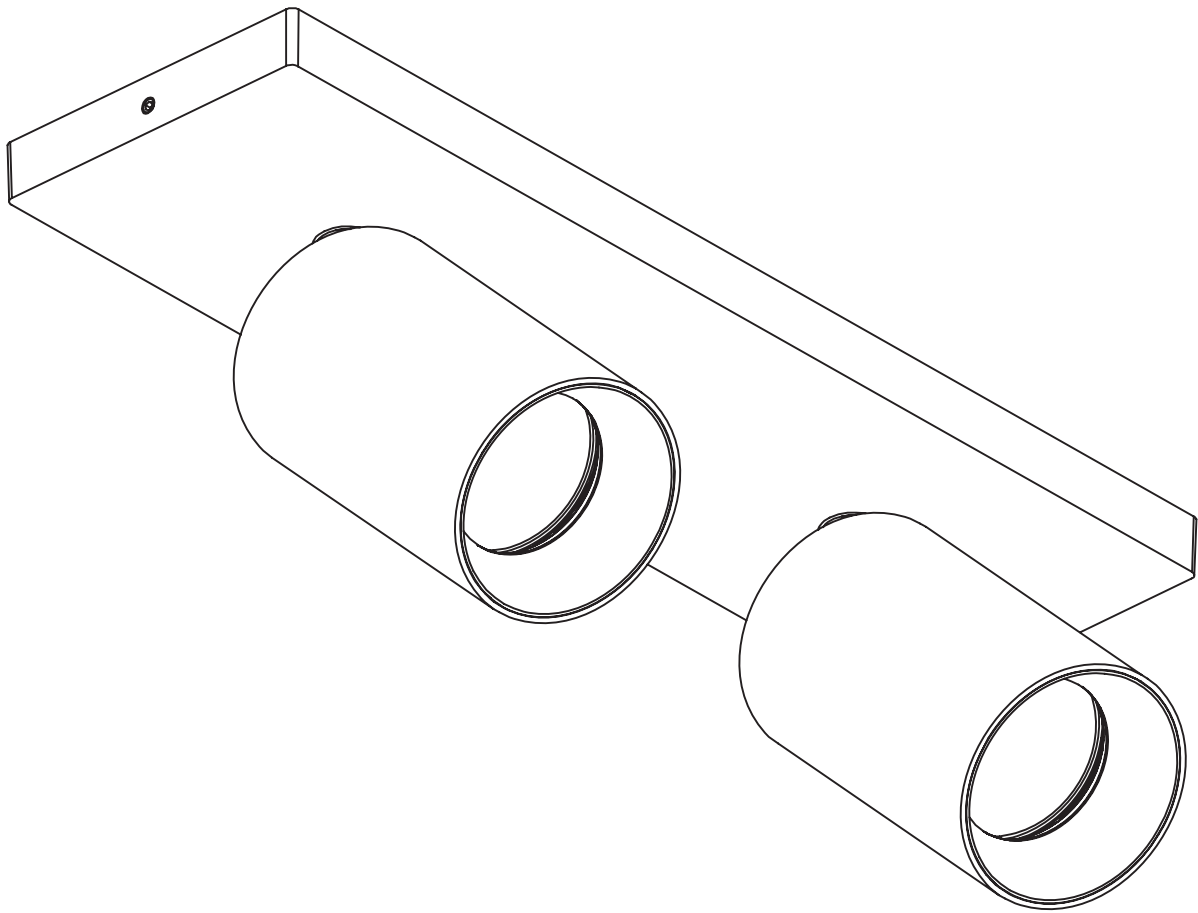

Tania Mini S2

INSTALLATION MANUAL

**⚠ Safety Notes:**

- The product must be installed, maintained, and operated as instructions below.
- Before starting installation of this product, make sure power supply is disconnected.
- Only to be installed by authorized electrician.
- Do not use abrasives or solvents when cleaning.
- Do not install the product if it appears damaged in any way. Check with manufacturer if in doubt.
- Do not modify this fitting in any matter as this will void warranty.
- Check protection class, if class I, it must be earthed.
- Disconnect power supply before maintenance or cleaning.

⚠ Sikkerhetsinformasjon:

- Følg installasjonsmanual for korrekt montering.
- Koble alltid fra strømmen før montering eller vedlikehold.
- Kan kun monteres av autorisert elektriker.
- Monter ikke produktet hvis det er synlig skade. Kontakt forhandler eller produsent.
- Bruk ikke løsemidler ved rengjøring
- Produktet skal ikke under noen omstendigheter endres eller modifiseres.
- Sjekk produktets isolasjonsklasse. Ved isolasjonsklasse I skal produktet jordes.

